

F25

FLOOR SCRUBBER

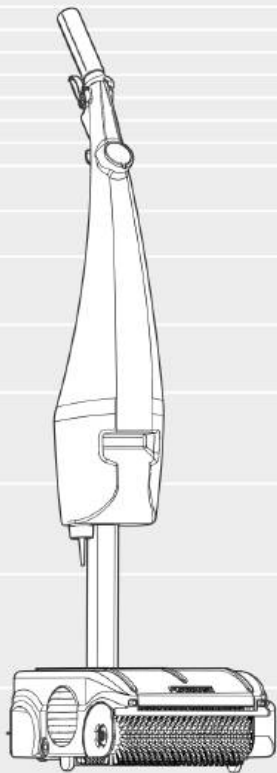

MANUAL OF USE AND MAINTENANCE

FLOORWASH[®]

Foreword	3
Manual content, use and maintenance	3
Storage of manual of use and maintenance	3
Machine delivery	3
F25 technical description	3
Serial number	3
General safety rules	3
Recommendations	4
Warnings	5
Technical data	6
Spare parts	7
Packaging specifications and dimensions	8
Machine unpacking	8
Machine assembly	9
How to get started	10
ON/OFF	11
Functioning	12
Transport	14
After cleaning	14
Maintenance	16
Troubleshooting tips	17

FOREWORD

It is of outmost importance to keep the machine at its maximum efficiency by carrying out the maintenance described in this manual carefully. It is important to keep this instruction manual in a safe place so that it can be referred to whenever necessary. For further requirements, please contact our customer service centre or your nearest authorised dealer.

MANUAL CONTENT, USE AND MAINTENANCE

The following manual has been drawn up to provide customers with all necessary information in order to use the machine as safely and smoothly as possible.

STORAGE OF MANUAL OF USE AND MAINTENANCE

The manual of use and maintenance should be kept in a safe and easy accessible place in the immediate proximity to the machine. To avoid compromising its readability, keep this manual away from sources of heat, liquids or detergents.

MACHINE DELIVERY

The F25 machine is delivered in a protective packaging. Ensure that the packaging is fully intact and that there are no signs of tempering when the product is taken over. The customer should notify our customer service immediately in case of damages.

F25 TECHNICAL DESCRIPTION

The F25 is a mechanical floor scrubber-dryer that ensures effective cleaning surfaces including uneven superficies. The combined mechanical action of brush, water and centrifugal force will guarantee the best results with minimum effort. It cleans, rubs and collects the filth and it is perfect for constant and frequent use. This scrubber dryer is particularly suited for the treatment and cleaning of floors made of terracotta, pottery, setts, clinker, rubber, resin, marble, linoleum, raw concrete, flagstone, serizzo granite, stone, carpets and rugs.

SERIAL NUMBER

The label with the serial number is located below the machine, in the underlying part of the external left side. That number shall be always notified for technical assistance or request of spare parts.

GENERAL SAFETY RULES

This floor scrubber-dryer is easy to use; anyway, it is necessary to read the following rules carefully in order to avoid damages to both the operator and the machine.

Recommendations

- The machine is not intended to be used by persons (including children) whose physical, sensory and mental capacities are impaired, or with lack of the necessary experience and knowledge, unless they are supervised or instructed in its use by persons responsible for their safety.
- Children shall be supervised to ensure that they do not play with the machine.
- If the power supply is damaged, it shall be replaced by the manufacturer or its authorised technical assistance.
- This machine is suitable for indoor use only.
- Do not use the machine on slopes.
- In case of emergency, remove the power cable from the outlet promptly.
- Unplug the power cable from the outlet before maintenance is performed.
- Use only brushes provided with the machine or supplied by an authorised dealer and/or reseller to avoid compromising safety and warranty.
- The machine shall not be left unattended, but stored in a protected area to prevent the machine from being moved accidentally.

Warnings



Always unplug the power cable from the outlet when not in use or before adjustments and maintenance are performed.



Do not use or keep the machine outside in wet conditions, and avoid direct exposure to rain.



Do not hold the plug or machine with wet hands.



The machine is suitable for use in dry conditions at a temperature range of +5°C to +35°C (+41°F to +95°F).



The power outlet socket of the machine shall be connected to an approved earth.



Do not insert objects through openings. Do not use when openings are clogged.



Protect the machine from sunlight and UV radiation.



Do not suck gases, liquids or potentially explosive and combustible dusts. These substances may corrode materials used in the construction of the machine.



Follow the basic safety rules for use in hazardous areas, such as service station or gas distributors.



Do not use the machine in potentially explosive atmospheres.



Do not place containers holding liquids on the machine.



Do not pull the power cable to carry the machine.



Keep the electrical cable away from sources of heat.



For use in work environments, do not hit shelves or scaffoldings where there is a risk of objects falling. The user shall be equipped with adequate safety equipment (gloves, footwear, helmet, goggles, etc.).



Request original spare parts only to dealers and/or authorised resellers in case of parts replacement or maintenance.



Check the machine in an authorised service centre at least once a year.



Organise the disposal of waste materials complying scrupulously with current regulations.

TECHNICAL DATA

Machine height	140mm 285mm 330mm Ø86
Machine width	700 revolutions per minute
Machine length	Ø54 1145 revolutions per
Front brush	minute 250mm 200mq/h
Rear brush	400W 2800 revolutions per
Working width	minute 4l 1l 10kg
Work capacity	
Induction motor power	
Total storage capacity	
Recovery tank capacity	
Total empty weight	

SPARE PARTS

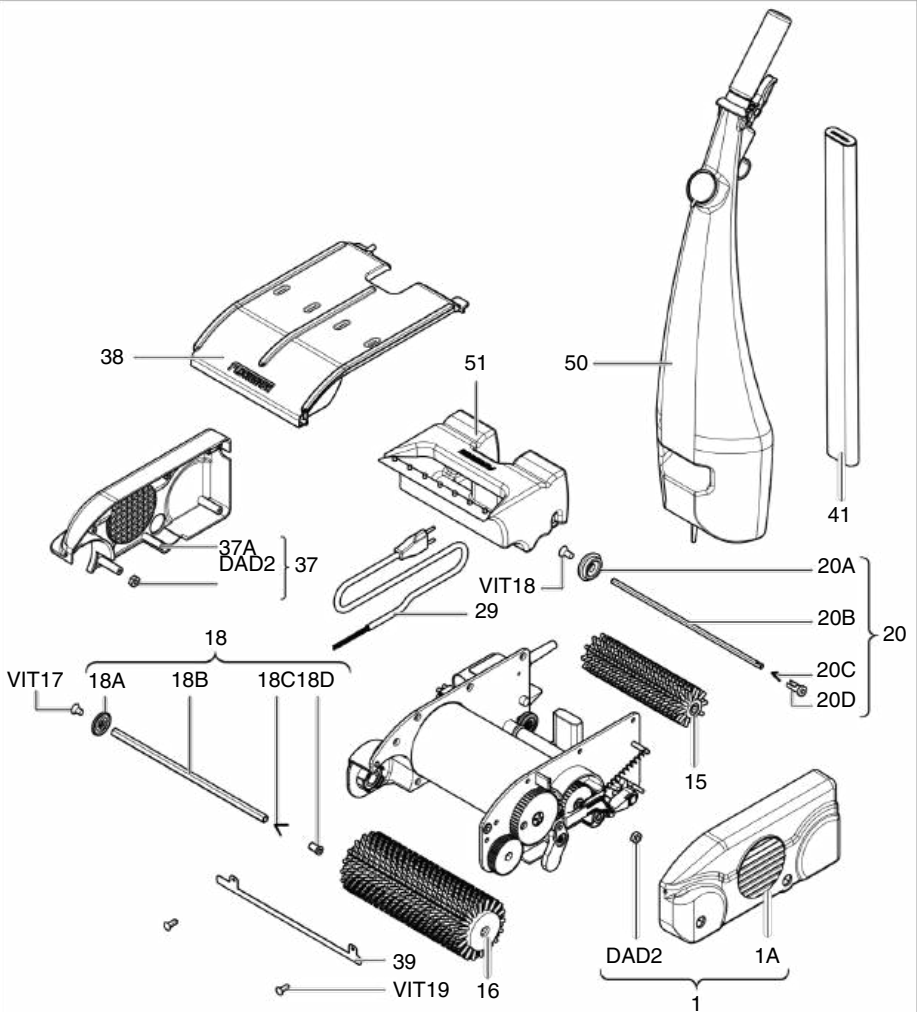

1	COMPLETE NYLON EXTERNAL LEFT SIDE	20	COMPLETE HEXAGON SPRING PLUNGER CH7
1A	NYLON EXTERNAL LEFT SIDE	20A	HEXAGON PLUNGER INSERT BUTTON CH7
DAD2	LOW SQUARE NUT 4MA	20B	HEXAGON PLUNGER CH7
CAF25	MACHINE BODY F25	20C	SPRING LATCH FOR HEXAGON PLUNGER CH7
15	UNIVERSAL REAR BRUSH	20D	HEXAGON PLUNGER EJECT BUTTON CH7
16	UNIVERSAL FRONT BRUSH	37	COMPLETE NYLON EXTERNAL RIGHT SIDE
18	COMPLETE HEXAGON SPRING PLUNGER CH10	37A	NYLON EXTERNAL RIGHT SIDE
18A	HEXAGON PLUNGER INSERT BUTTON CH10	38	COMPLETE COVER F25
18B	HEXAGON PLUNGER CH10	41	COMPLETE HANDLE
18C	SPRING LATCH FOR HEXAGON PLUNGER CH10	50	COMPLETE TANK
18D	HEXAGON PLUNGER EJECT BUTTON CH10	51	WASTE WATER TANK

PACKAGING SPECIFICATIONS AND DIMENSIONS

The F25 machine is delivered in a protective packaging. Ensure that the packaging is fully intact and that there are no signs of tempering when the product is taken over. In case of damage, the customer shall notify our customer service immediately.

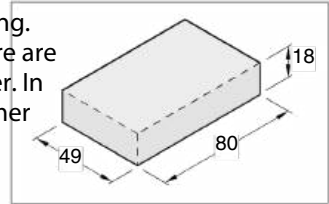

MACHINE UNPACKING

Follow the procedure below:

- 1 Place the packaging on the floor/work table softly by laying it down on the right part.
- 2 Open the external cardboard by using a pair of scissors, when necessary. (Do not use an utility knife).
- 3 Remove the machine body, tank and extensible tube, and place them on the floor softly.
- 4 Keep the cardboard box and its components away from sources of heat, in a dry and easily accessible place.



Do not break or throw the packaging and its components away so that it can be used again for future transportation.



For your safety, wear protective gloves when carrying out these operations, in order to avoid injuries in case of accidental contact with sharp edges of the cardboard box, direct contact with detergent residues or metal edges.

MACHINE ASSEMBLY

Follow the procedure below:



The F25 machine has a fast assembly system since no tools are required. Do not use any tool to avoid injuries or damage to the machine.

- 1** Place the body of the machine on a stable surface without slopes.

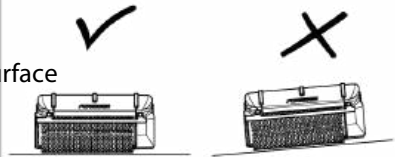

- 2** Insert the handle in the axle of the machine body.

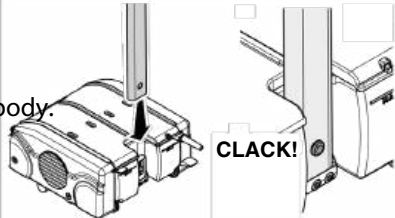

- 3** Insert the tank in the handle at the desired height (3 different heights).

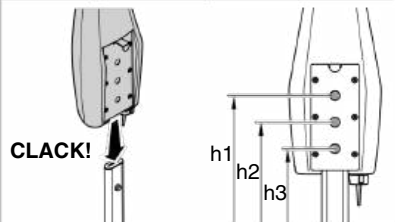

- 4** Insert the small transparent water tube in the relief valve situated on the lower part of the tank.

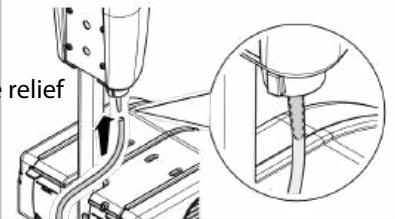

- 5** Hook the electrical cord into its appropriate seat situated at the top end of the tank.



HOW TO GET STARTED



The F25 machine is a mechanical collection device that can achieve excellent results even with the use of water without detergent. An excellent result is achieved with the use of specific detergents.



The machine comes with universal brushes (gr 0.12). Anyway, it is possible to request



specific brushes to our customer service according to the type of surface to be treated.



Use foam-controlled detergents to avoid excessive foaming. Do not use pure acids.

Wear protective gloves before handling detergents, alkaline or acid solutions to avoid hand injuries.

1 Remove the tank cap.

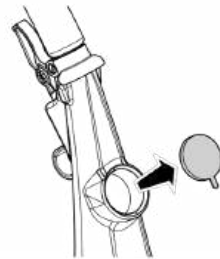

2 Pour the liquid, clean water and/or detergent in the concentration specified on the label.

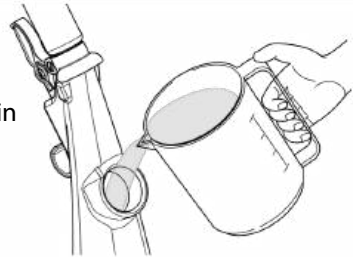

3 Replace the tank cap.

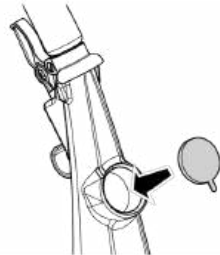

Fill the tank with clean water and/or detergent for a maximum of 2lt. Use water at a temperature not exceeding 40°C or below 10°C.(104°F – 50°F).

ON/OFF



Before the start-up of the device, check that the electrical cord and the machine are not malfunctioning in any way. If this is not the case, do not use the device and contact our service centre as soon as possible.

1 Insert the plug in a 230-volt wall outlet.

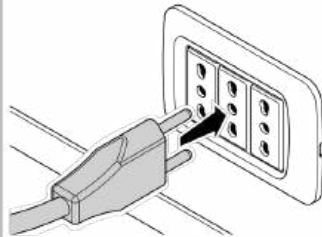

2 Press the kick-start pedal situated at the bottom - right side of the machine.

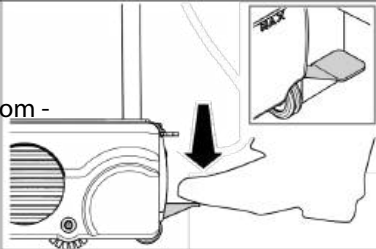

It is important to press the kick - start pedal completely before lowering the tank towards you, so as to avoid any damage to the central axle of the machine body.

3 While pressing the kick-start pedal, lower the tank towards you slowly. At this point, the machine will switch on automatically and brushes will start rotating.

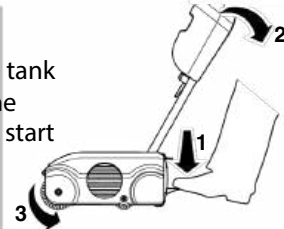

4 The machine will switch off automatically when returning the tank to a vertical position (rest position).

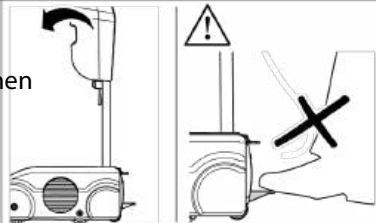

Do not press the kick - start pedal when returning the tank to the original position.

FUNCTIONING

Check that all steps described above have been completed correctly before using the machine



Before starting the washing procedure with the machine, remove any solid residual such as dust lumps, stones, glass, paper etc. from the surface which has to be treated.

- 1 After the engine has turned on, move the machine back and forth with linear movements. The lever placed beneath the handle will allow you to dispense the liquid previously poured in the tank.

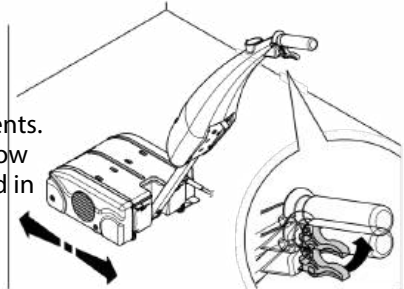

The engine of this machine has a safety device that will turn the machine off in the event of an overload. In this case, rest the machine for 15 minutes, and then continue from where you left off. If the engine does not function properly, contact our service centre.



Do not make circular movements with the machine so that it can collect the dispensed liquid.

- 2 After pulling the lever, the liquid will distribute uniformly on the front cylinder brush.

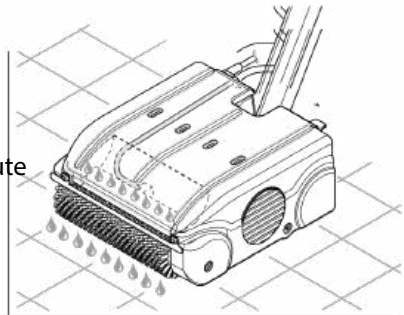

In the ongoing stage just pull the lever halfway; in the returning stage, release the lever allowing the liquid recovery.



In the returning stage, the machine shall pass through the same hallway of the ongoing stage, thus allowing a complete recovery of the dispensed liquid.

3 The recovery of the dispensed liquid occurs automatically by means of mechanical collection. The liquid will flow into the waste situated in the lower part of the machine.

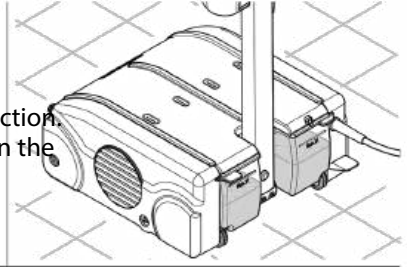

It is important to empty the waste when the seep liquid reaches the maximum mark on the back of the waste, thus avoiding an accidental release of the same.

TRANSPORT

To transport the machine safely, follow these steps:



Check that the tank is placed in a vertical position before moving the machine. The electrical cord shall be unplugged from the outlet.

- 1 The machine has two rubber wheels situated in the lower part. By pulling the tank towards you, without pressing the kick-start pedal, the front part of the machine will be lifted up, guaranteeing an easy transportation.

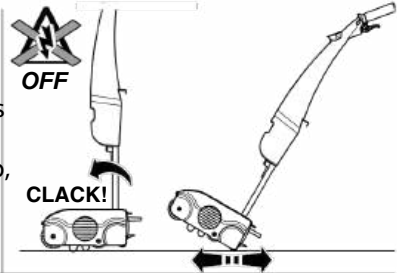

If the liquid in the waste has reached the highest level, it is necessary to empty it before using the machine.

- 2 It is possible to lift the entire machine up, in order to move it to an upper floor of the house, by using the designated slit situated on the lower part of the tank.



Do not lift the machine up by using the upper knob of the tank.



For transportation with vehicles, ensure the machine so that it cannot in any way move.

AFTER CLEANING

After cleaning, follow these steps:



Before carrying out any operation, check that the electrical cord is unplugged from the outlet.



Wear protective gloves when carrying out these operations, in order to avoid direct contact with detergent residues or metal edges.

1 Open the upper cover of the machine by pushing the two lateral hooks up.

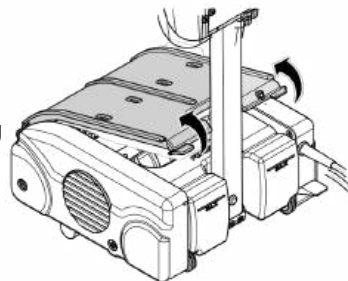

2 Remove and empty the dirty water waste. Wash it with running water and, if necessary, use a spatula to remove any residual from the bottom.

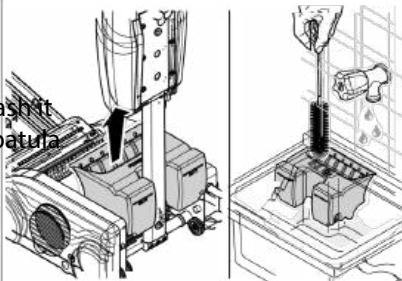

The stainless-steel sheet welded to the waste is not removable. Do not try to remove

3 Unhook the upper cover and wash it gently with running water. Check that the drip tray and the water tube are not clogged.

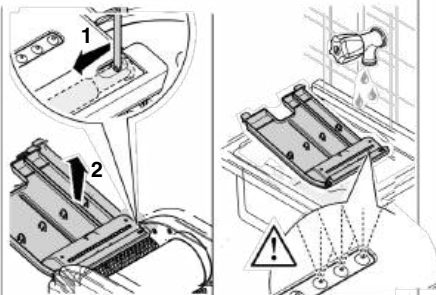

4 Unhook and drain the clean water tank 2 from any residual of water and/or detergent.

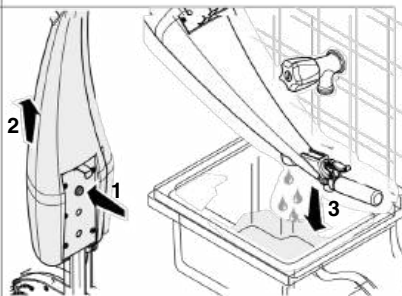

Do not place the foot on the machine body while carrying out this operation.

MAINTENANCE

A regular maintenance keeps the machine safe and always ready to use. Carry out the following operations:



Before carrying out any operation, check that the electrical cord is unplugged from the

- 1 Keep the machine in a safe place to ensure its maintenance.

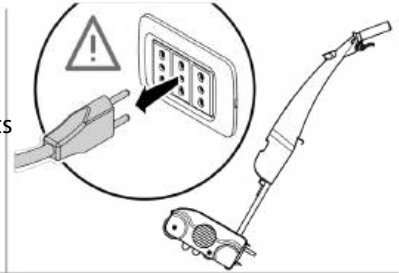

Wear protective gloves when carrying out these operations, in order to avoid direct contact with metal edges or sharp plastic parts.

- 2 Unhook the handle from the machine body and place it on a work table.

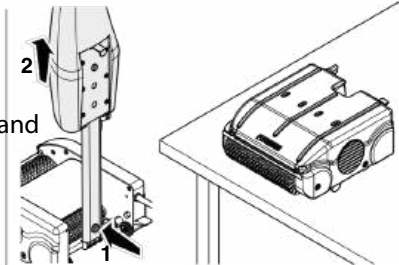

- 3 Unhook the upper cover of the machine and wash it thoroughly with running water.

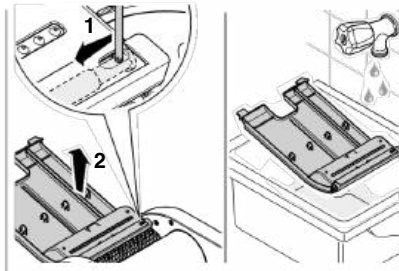

- 4** Remove the brushes by pressing the button placed on the left side of the machine. Use a damp cloth to clean the internal sides of the machine while checking that seals are not clogged.

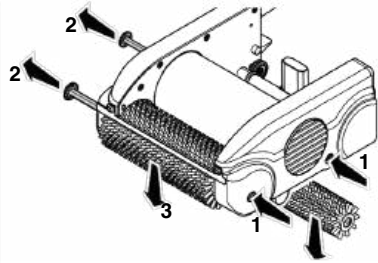

Do not clean the machine with steam cleaners.

TROUBLESHOOTING TIPS

The following are examples of some problems that may arise.



If after completing the verifications listed below, you do not achieve positive outcome contact our service support immediately.

The machine does not work

Check that the power cord plug is inserted correctly. (230V) Check that the power cord is not damaged or has got stripes.

The engine turns on but brushes do not rotate

Unplug the power cable and check that the central conveyor belt is able to rotate by trying to move it by hand.

The fresh water tank loses

Check that the water valve of the cable is fully screwed to the tank.

Check that the drive cable anchored to the lever of the liquid distribution is not too taut.

Check that the tank is fully intact and that there are no holes and/or cracks.

The machine does not distribute well the wash water

Make sure that the drip tray placed under the cover is not clogged. Check that the transparent tube is not clogged or crimped.

The machine does not collect water

Check that the waste is properly inserted and that the cover is completely closed and attached to the body. Check that the wash water drops on a regular basis when you pull the lever. Check that the brushes are not too worn.

FLOORWASH[®]

FLOORWASH®

F.C.M. S.r.l.
Via Lorenzo Lotto, 12 - Grumello Del Monte (BG) Italy
tel +39 035.4491316 - fax +39 035.830912
info@floorwash.com